

EST-FS1091 SERIES

Color selection

B **S** **W**

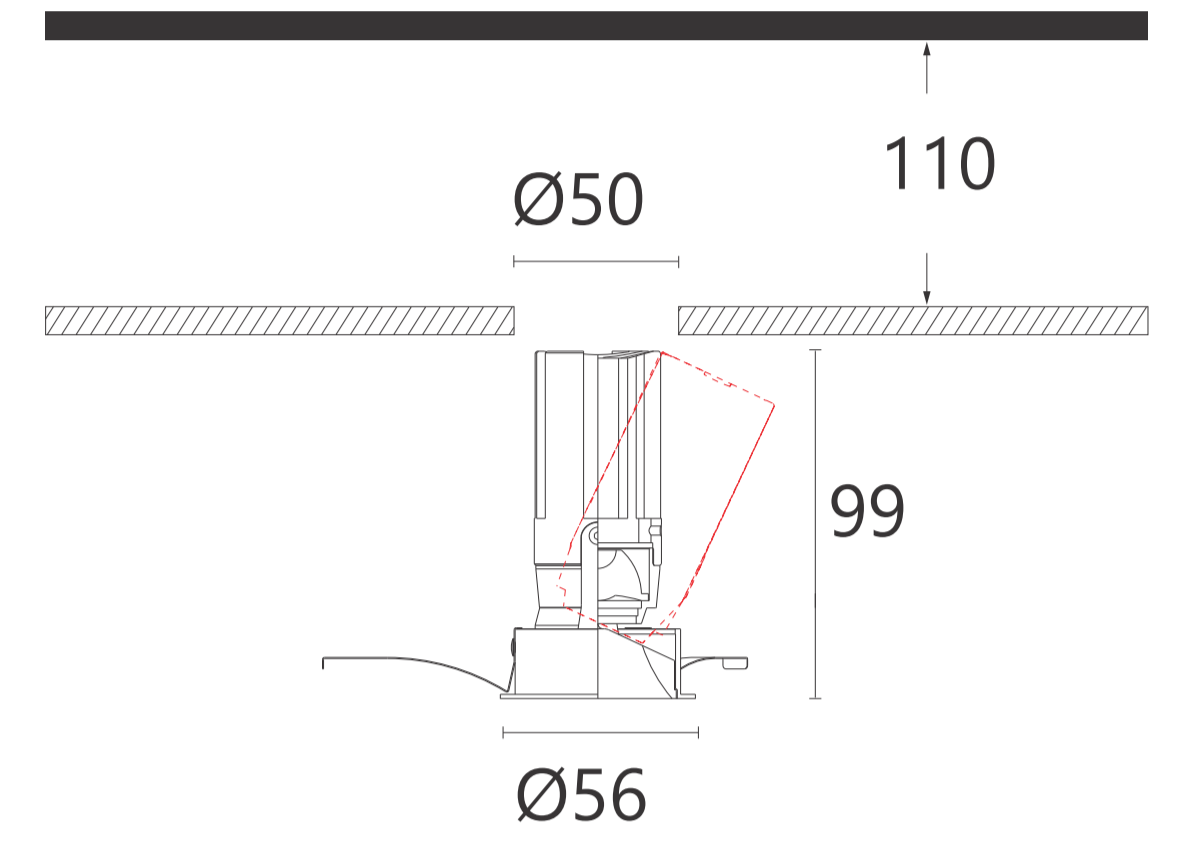

	Power	LED InPut	CCT	Lm	CRI	Operating Temp
FS1091A-10 Max.9W	9W	DC200mA	2700K	624lm	CRI90	-30 °C +40 °C
	9W	DC200mA	3000K	640lm	CRI90	-30 °C +40 °C
	9W	DC200mA	4000K	670lm	CRI80	-30 °C +40 °C
	9W	DC200mA	5000K	690lm	CRI80	-30 °C +40 °C

- Remote Driver: AC100-240V 50/60Hz
- Driver performance: Non-dimmable/dimmable
- Dimmer: DALI/0~10v/Triac

