

EST-JRF4-M

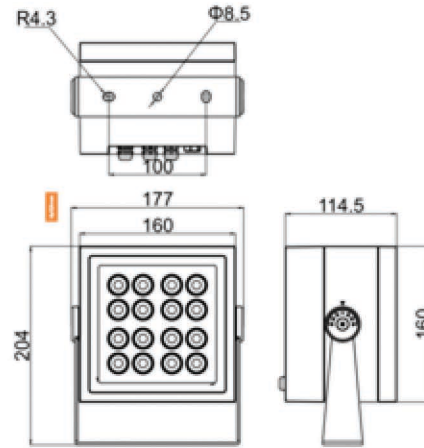

Product Dimension

Product Specification

Product name	EST-JRF4-M-60	EST-JRF4-M-40
LED Quantity	16pcs	16pcs
Rated Power	56W	38W
Input Voltage	AC100-277V 50/60Hz	AC100-277V 50/60Hz
Control Mode	ON-OFF	ON-OFF
Power Factor	> 0.9	> 0.9
Color	4000K	4000K
Luminous Flux	3895 lm	2828 lm
Color Rendering Index	> 80	> 80
Beam Angle	10°/15°/25°/30°/50°/10×35°	10°/15°/25°/30°/50°/10×35°
Temperature of Working Condition	-35-50°C	-35-50°C
Humidity of Working Condition	10-90%	10-90%
LED Lifetime	> 70000h	> 70000h
Protection Grade	IP66 IK08	IP66 IK08
Net Weight	2.9kg	2.9kg
Gross Weight	3.3kg	3.3kg
Packing Size	410×319×267mm	410×319×267mm

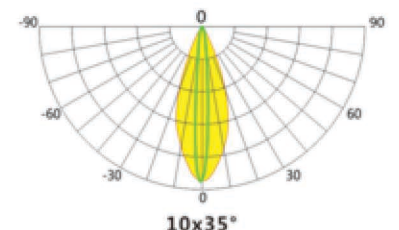
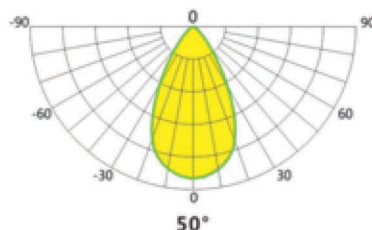
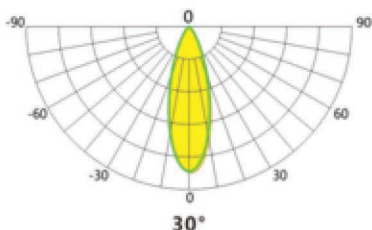
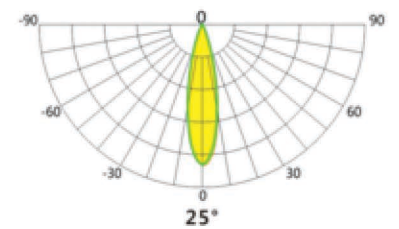
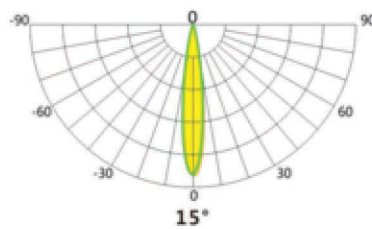
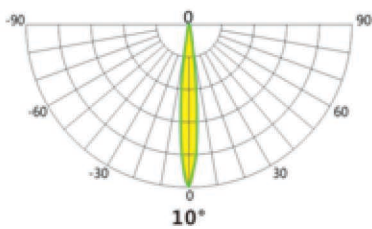

EST-JRF4-M

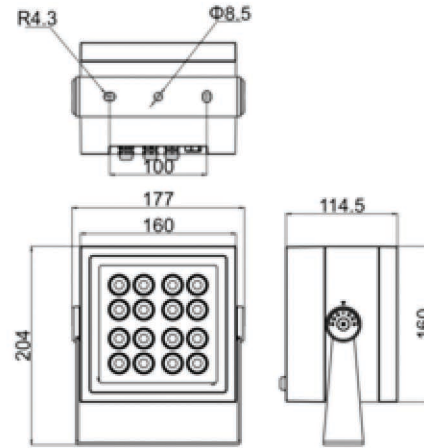

Product Dimension

Product Specification

Product name	EST-JRF4-M-30	EST-JRF4-M-20
LED Quantity	16pcs	16pcs
Rated Power	27W	18W
Input Voltage	AC100-277V 50/60Hz	AC100-277V 50/60Hz
Control Mode	ON-OFF	ON-OFF
Power Factor	> 0.9	> 0.9
Light Color	4000K	4000K
Luminous Flux	2240 lm	1600 lm
Color Rendering Index	> 80	> 80
Beam Angle	10°/15°/25°/30°/50°/10×35°	10°/15°/25°/30°/50°/10×35°
Temperature of Working Condition	-35-50°C	-35-50°C
Humidity of Working Condition	10-90%	10-90%
LED Lifetime	> 70000h	> 70000h
Protection Grade	IP66 IK08	IP66 IK08
Net Weight	2.9kg	2.9kg
Gross Weight	3.3kg	3.3kg
Packing Size	410×319×267mm	410×319×267mm

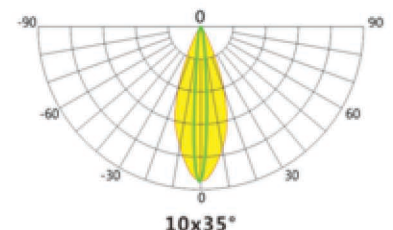
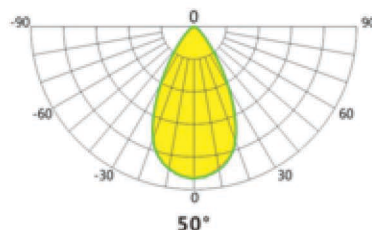
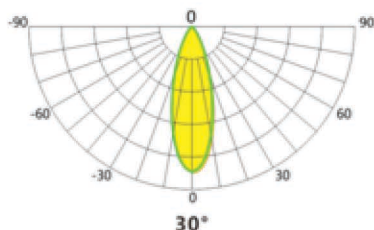
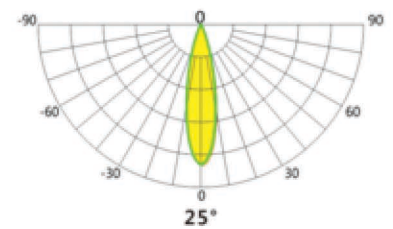
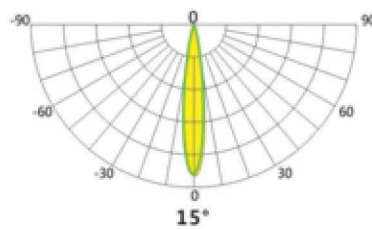
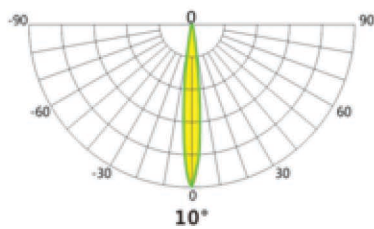

EST-JRF4-M

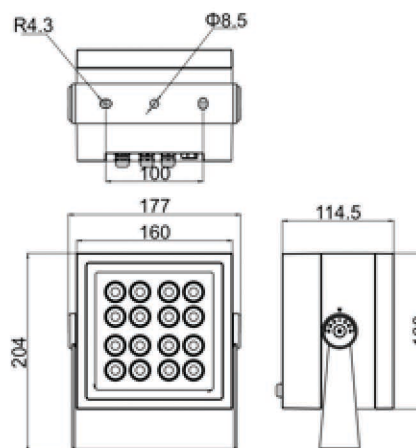

Product Dimension

Product Specification

Product name	EST-JRF4-M-40-C	EST-JRF4-M-30-C	EST-JRF4-M-20-C
LED Quantity	16pcs	16pcs	16pcs
Rated Power	40W	30W	20W
Input Voltage	AC100-277V 50/60Hz	AC100-277V 50/60Hz	AC100-277V 50/60Hz
Control Mode	DMX512	DMX512	DMX512
Power Factor	> 0.9	> 0.9	> 0.9
Light Color	Single Colour/RGBW	Single Colour/RGBW	Single Colour/RGBW
Luminous Flux	1610 lm	1312 lm	950 lm
Color Rendering Index	W > 80	W > 80	W > 80
Beam Angle	10°/15°/25°/30°/50°/10×35°	10°/15°/25°/30°/50°/10×35°	10°/15°/25°/30°/50°/10×35°
Temperature of Working Condition	-35-50°C	-35-50°C	-35-50°C
Humidity of Working Condition	10-90%	10-90%	10-90%
LED Lifetime	> 70000h	> 70000h	> 70000h
Protection Grade	IP66 IK08	IP66 IK08	IP66 IK08
Net Weight	3.0kg	3.0kg	3.0kg
Gross Weight	3.4kg	3.4kg	3.4kg
Packing Size	410×319×267mm	410×319×267mm	410×319×267mm

