

Architectural Spot Light and Garden Light

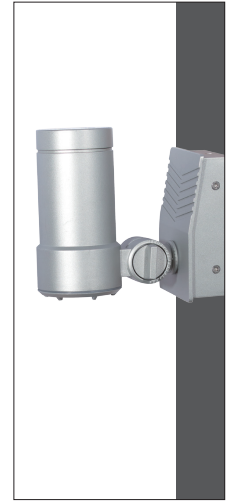

Architectural Spot Light



R3TMM0124

R3TNM0126

R3TOM0128

B3TFM0171

LED Colour Temperature

3000K
6000K

Material specifications

Housing	12# Die-casting dark grey powder coated aluminum. T=60-80µm. Adhesion of ISO class 1/ASTM class 4B
Light Window	Tempered glass. T=4mm
Gasket	Tooling shaped seal
LED	Nichia
LED Driver	Constant Voltage Input, Constant Current Output
Lens/Reflector	Optical lens, efficiency ≥ 85%
Power Cable	H05RN-F 2X1.0mm ² L=0.3m (low voltage) H05RN-F 3X1.0mm ² L=0.3m (high voltage)



Optics

R7 R0118C035XL 18° R0124C035XL 24° R0132C035XL 32°	R14 R0115C044SH 15° R0125C044SH 25° R0140C044SH 40° R0160C044SH 60°
R23 R0122C0298H 22°	B56 L0115D070LK 15° L0124D070LK 24° L0138D070LK 38°

Housing Color Option

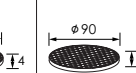

Honeycomb Louver

 Ø42	 Ø55	 Ø63	 Ø90
Mh024	Mh025	Mh026	Mh027

Outer Dimensions

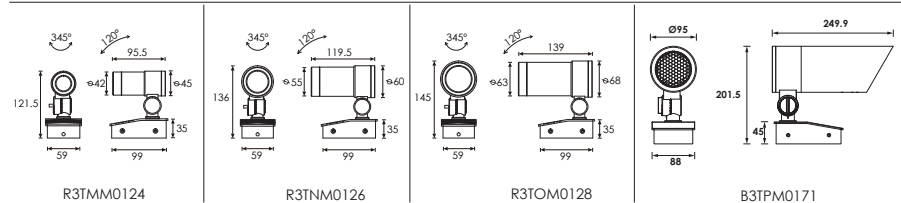

R3TMM0124

R3TNM0126

R3TOM0128

B3TFM0171

+9198 8640 006

www.est.net.in

Item	Light source	Reflector or Lens	The manufacturer selected lens degree(°)θ1/2	Input voltage(V)	Typical operating current(mA)	Typical consumption(W)	Typical luminance(lm)	IK rate
R3TMM0124	1×4W	R23	22°	24V DC 120/240	2.4 V = 175 120V = 38 240V = 26	2.4 V = 4.1 120V = 4.5 240V = 5.1	Cool white =285 Warm white =255	06
R3TNM0126	1×6W	R7	24°	24V DC 120/240	2.4 V = 270 120V = 60 240V = 35	2.4 V = 6.5 120V = 7.4 240V = 7.4	Cool white =670 Warm white =593	06
R3TOM0128	1×10W	R14	25°	24V DC 120/240	2.4 V = 480 120V = 107 240V = 55	2.4 V = 11.5 120V = 12.6 240V = 12.3	Cool white =1080 Warm white =1000	06
B3TFM0171	1×20W	B56	24°	24V DC 120/240	2.4 V = 958 120V = 180 240V = 93	2.4 V = 23 120V = 25 240V = 25.8	Cool white =1494 Warm white =1315	06

R3TMM0124

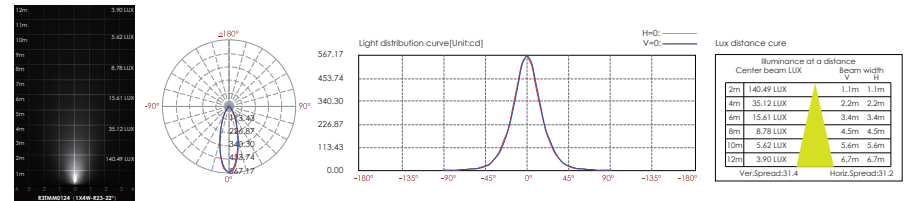

R3TNM0126

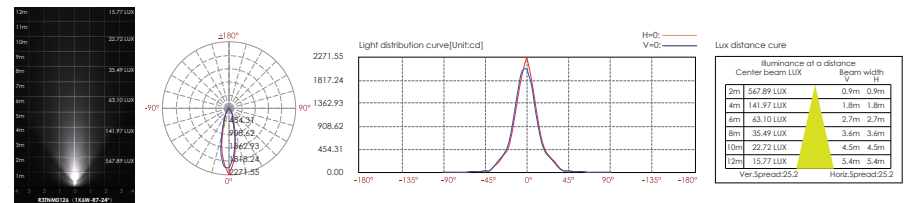

R3TOM0128

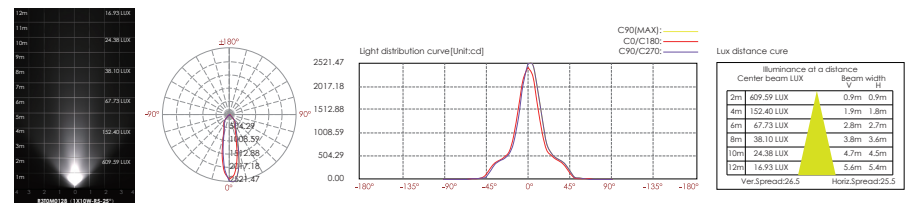

B3TFM0171

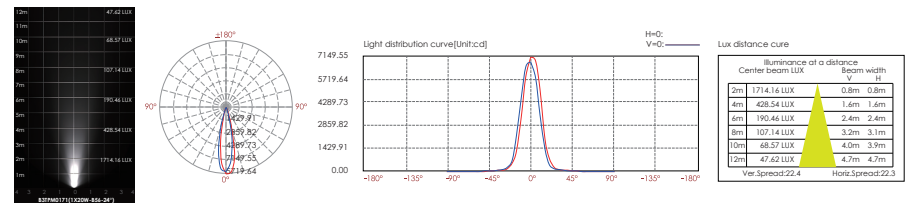

+9198 8640 006

www.est.net.in



Optional parts
Tree/pole strap

Outer Dimensions Unit:mm

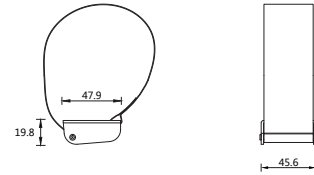

RD001

Material:
nylon belt, Aluminum. 1056# fasten buckle



Multi-function base----compatible for both wall mounting and tree/pole strap mounting



R3TMM0124

R3TNM0126

R3TOM0128

B3TPM0171

Outer Dimensions Unit:mm

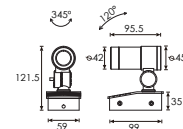

R3TMM0124

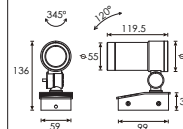

R3TNM0126

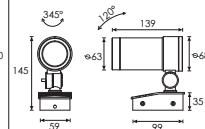

R3TOM0128

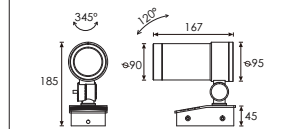

B3TPM0171

Optional parts
Bevel cut hood



Outer Dimensions Unit:mm

CA3009	CA3010	CA3011	CA3013

Material : Aluminium 6063#

Optional Parts: Bevel Cut Hood/Cap

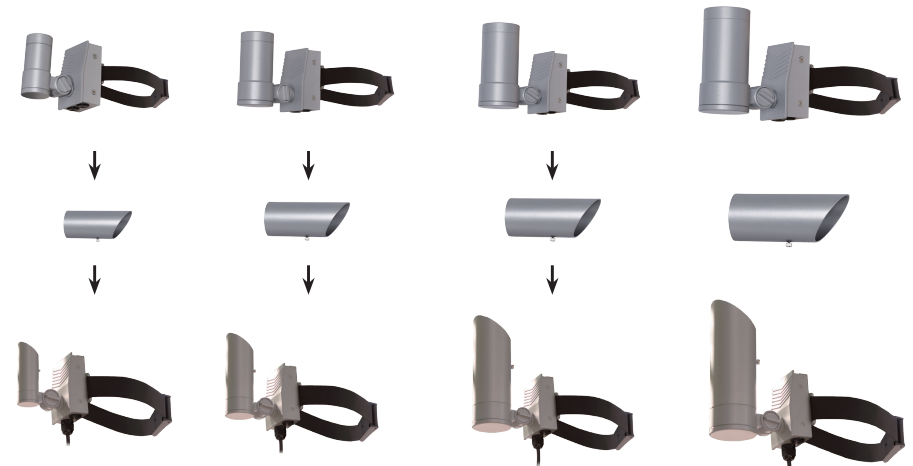
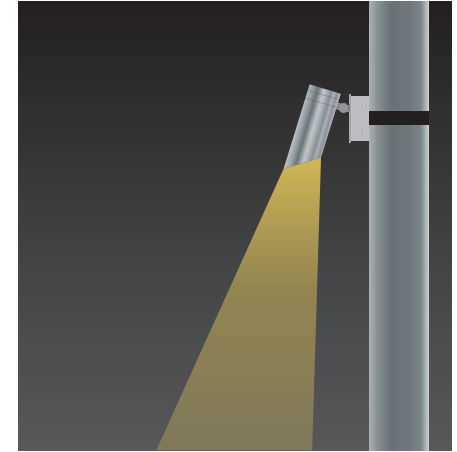

R3TMM0124 R3TNM0126 R3TOM0128 B3TPM0171

Outer Dimensions Unit:mm

R3TMM0124	R3TNM0126	R3TOM0128	B3TPM0171

Optional parts
Stick



R3TMP0124

R3TNP0126

R3TOP0128

Outer Dimensions

Unit:mm

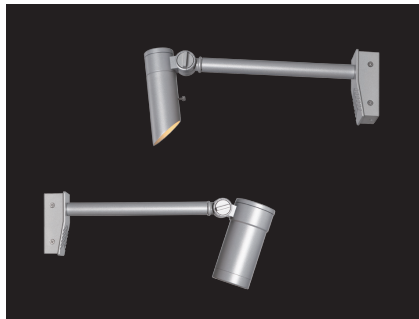
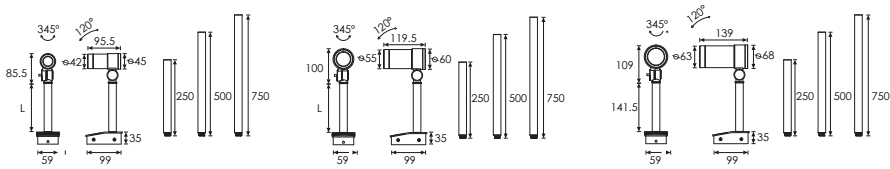

Tu001
25CM

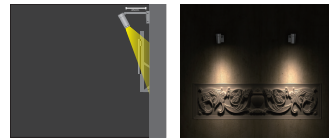

Tu002
50CM

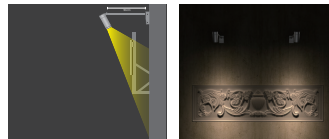

Tu003
75CM

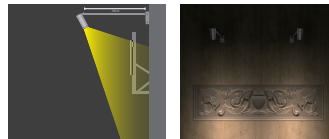

Optional parts
Bevel cut hood

Outer Dimensions

Unit:mm

CA3009	CA3010	CA3011	CA3013

Material : Aluminium 6063#

