



+91 98 8640 0069 | kartik@est.net.in

Hong Kong | Bangalore | Mumbai | Shenzhen | London

www.rhealedlinear.com



Recessed LED downlight with quality aluminum body in powder-coated, with multiple reflecting angles of anti-dazzle reflector for selection, excellent heat sink capability, remote LED driver.

Application: supermarkets, chain stores, shopping mall, villas, hotels, halls.

LED SPOT LIGHT



SPOT LIGHT



Φ142



H



Φ130mm

30° 350°



Frosted Glass



Clear Glass

| Model | P | H |
|-----------|---------|-----|
| FS1060-30 | Max.30W | 128 |
| FS1060-35 | Max.35W | 138 |
| FS1060-42 | Max.42W | 153 |

Operating Temp. : -30°C + 40°C
26W COB chip (DC700mA) / FS1060-30

- 2700K/2107lm Ra90
- 3000K/2340lm Ra90
- 4000K/2645lm Ra80
- 5000K/2943lm Ra70

Remote Driver: AC100-240V 50/60Hz
Driver performance: Non-dimmable/dimmable
Dimmer: DALI/0~10v/Triac

Beam angle

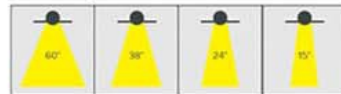

Color selection

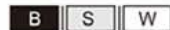

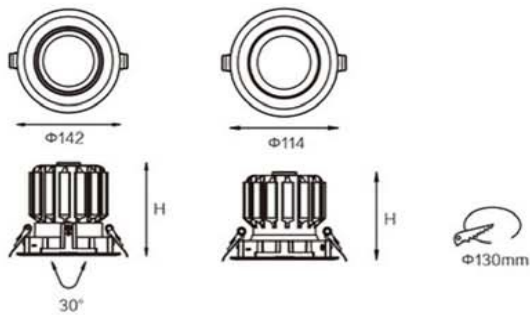

| Model | P | H |
|-----------|---------|-----|
| FS5070-30 | Max.30W | 113 |
| FS5070-35 | Max.35W | 123 |
| FS5080-30 | Max.30W | 106 |
| FS5080-35 | Max.35W | 116 |

Operating Temp. : -30°C + 40°C
 26W / 30W COB chip (DC700mA / DC800mA)
 ■ 2700K/2115lm Ra90
 ■ 3000K/2280lm 2735lm Ra90
 ■ 4000K/2640lm 3080lm Ra80
 ■ 5000K/2910lm 3435lm Ra70

Remote Driver: AC100-240V 50/60Hz
 Driver performance: Non-dimmable/dimmable
 Dimmer: DALI/0~10v/Triac

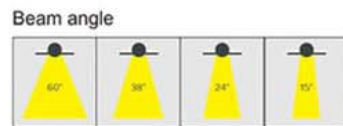

Color selection
 B S W

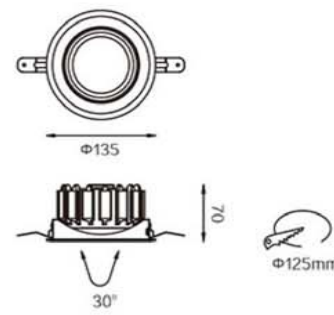

FS5072-25
 Max.25W

Operating Temp. : -30°C + 40°C
 23W COB chip (DC600mA)
 ■ 2700K/1750lm Ra90
 ■ 3000K/1975lm Ra90
 ■ 4000K/2250lm Ra80
 ■ 5000K/2450lm Ra70

Remote Driver: AC100-240V 50/60Hz
 Driver performance: Non-dimmable/dimmable
 Dimmer: DALI/0~10v/Triac

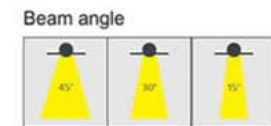

Color selection
 B S W



Φ100



Φ94mm

| Model | P | H |
|-----------|---------|----|
| FS5041-15 | Max.15W | 82 |
| FS5042-22 | Max.22W | 97 |

- Operating Temp. : -30°C + 40°C
 13W / 19W COB chip (DC350mA / DC500mA)
- 2700K/1050lm 1543lm Ra90
 - 3000K/1170lm 1716lm Ra90
 - 4000K/1326lm 1936lm Ra80
 - 5000K/1470lm 2156lm Ra70

Remote Driver: AC100-240V 50/60Hz
 Driver performance: Non-dimmable/dimmable
 Dimmer: DALI/0~10v/Triac



Frosted Glass



Clear Glass

Beam angle

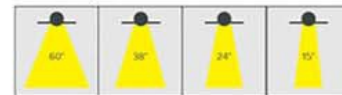

Color selection

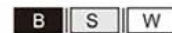

Φ82



82



Φ76mm



Frosted Glass



Clear Glass

FS5045-15
 Max.15W

- Operating Temp. : -30°C + 40°C
 13W COB chip (DC350mA)
- 2700K/1050lm Ra90
 - 3000K/1170lm Ra90
 - 4000K/1320lm Ra80
 - 5000K/1470lm Ra70

Remote Driver: AC100-240V 50/60Hz
 Driver performance: Non-dimmable/dimmable
 Dimmer: DALI/0~10v/Triac

Beam angle

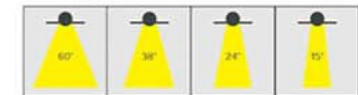

Color selection



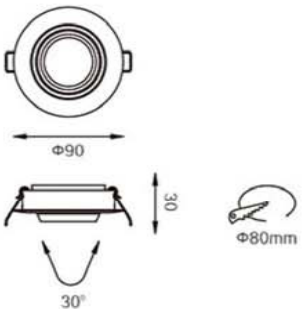

FS5053-05

Max.5W

Operating Temp. : -30°C + 40°C

4.5W COB chip (DC500mA)

- 2700K/365lm Ra90
- 3000K/397lm Ra90
- 4000K/443lm Ra80
- 5000K/490lm Ra70

Remote Driver: AC100-240V 50/60Hz

Driver performance: Non-dimmable/dimmable

Dimmer: 0~10v/Triac



Beam angle



Color selection

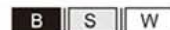

FS5040-03

Max.3W

Operating Temp. : -30°C + 40°C

2.5W COB chip (DC300mA)

- 2700K/219lm Ra90
- 3000K/265lm Ra90
- 4000K/267lm Ra80
- 5000K/294lm Ra70

Remote Driver: AC100-240V 50/60Hz

Driver performance: Non-dimmable/dimmable

Dimmer: 0~10v/Triac



Beam angle

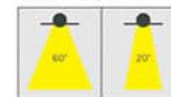

Color selection

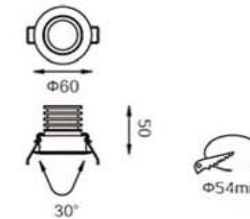

FS5040-02

Max.2W

Operating Temp. : -30°C + 40°C

1.5W COB chip (DC500mA)

- 2700K/145lm Ra90
- 3000K/156lm Ra90
- 4000K/177lm Ra80
- 5000K/198lm Ra70

Remote Driver: AC100-240V 50/60Hz

Driver performance: Non-dimmable/dimmable

Dimmer: 0~10v/Triac



Beam angle



Color selection

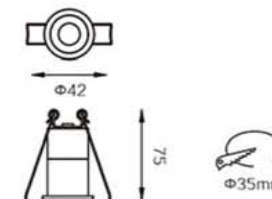

Simple and special design for easy dismounting. One module with different optional front housing
Two Wattage (13/26W) for selecting.



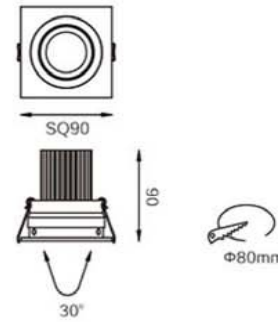
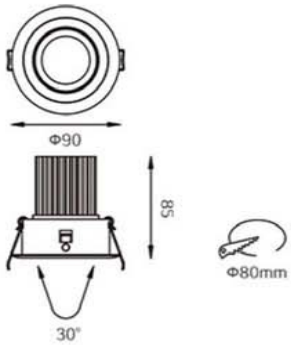

FS5048-13
Max. 13W

Operating Temp. : -30°C + 40°C
11W COB chip (DC450mA)
 ■ 2700K/926lm Ra90
 ■ 3000K/1019lm Ra90
 ■ 4000K/1144lm Ra80
 ■ 5000K/1275lm Ra70

Remote Driver: AC100-240V 50/60Hz
Driver performance: Non-dimmable/dimmable
Dimmer: 0~10v/Triac

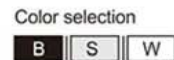
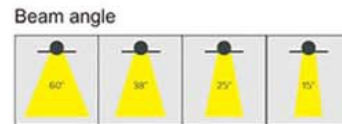

FS-5048A-13
Max. 13W

Operating Temp. : -30°C + 40°C
11W COB chip (DC450mA)
 ■ 2700K/926lm Ra90
 ■ 3000K/1019lm Ra90
 ■ 4000K/1144lm Ra80
 ■ 5000K/1275lm Ra70

Remote Driver: AC100-240V 50/60Hz
Driver performance: Non-dimmable/dimmable
Dimmer: 0~10v/Triac

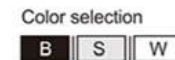
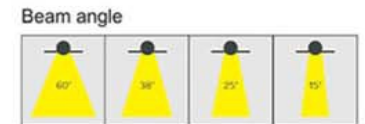

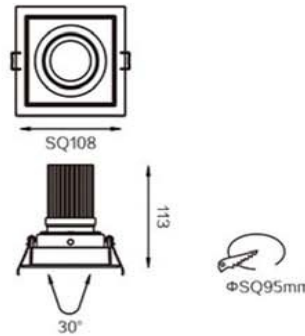
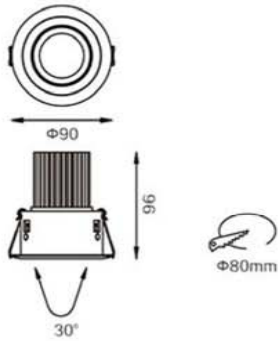

FS5047-13
Max. 13W

- Operating Temp. : -30°C + 40°C
11W COB chip (DC450mA)
- 2700K/926lm Ra90
 - 3000K/1019lm Ra90
 - 4000K/1144lm Ra80
 - 5000K/1275lm Ra70

Remote Driver: AC100-240V 50/60Hz
Driver performance: Non-dimmable/dimmable
Dimmer: 0~10v/Triac



FS5047A-13
Max. 13W

- Operating Temp. : -30°C + 40°C
11W COB chip (DC450mA)
- 2700K/926lm Ra90
 - 3000K/1019lm Ra90
 - 4000K/1144lm Ra80
 - 5000K/1275lm Ra70

Remote Driver: AC100-240V 50/60Hz
Driver performance: Non-dimmable/dimmable
Dimmer: 0~10v/Triac

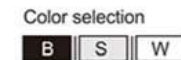



Φ138



105



Φ123mm

30°



Frosted Glass



Clear Glass

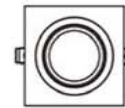

SQ138



105



Φ123mm

30°



Frosted Glass



Clear Glass

FS5050-26

Max.26W

Operating Temp. : -30°C + 40°C

23W COB chip (DC700mA)

- 2700K/1825lm Ra90
- 3000K/2028lm Ra90
- 4000K/2288lm Ra80
- 5000K/2548lm Ra70

Remote Driver: AC100-240V 50/60Hz

Driver performance: Non-dimmable/dimmable

Dimmer: DALI/0~10v/Triac

Beam angle

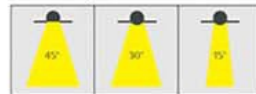

Color selection

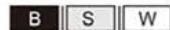

FS5050A-26

Max.26W

Operating Temp. : -30°C + 40°C

23W COB chip (DC700mA)

- 2700K/1825lm Ra90
- 3000K/2028lm Ra90
- 4000K/2288lm Ra80
- 5000K/2548lm Ra70

Remote Driver: AC100-240V 50/60Hz

Driver performance: Non-dimmable/dimmable

Dimmer: DALI/0~10v/Triac

Beam angle

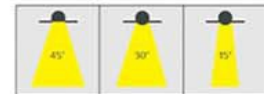

Color selection



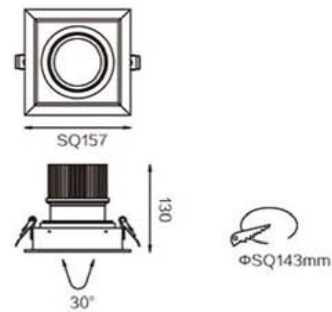
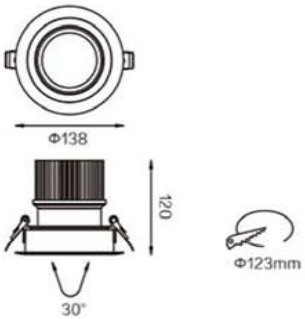

FS5049-26
Max.26W

Operating Temp. : -30°C + 40°C
23W COB chip (DC700mA)
 ■ 2700K/1825lm Ra90
 ■ 3000K/2028lm Ra90
 ■ 4000K/2288lm Ra80
 ■ 5000K/2548lm Ra70

Remote Driver: AC100-240V 50/60Hz
Driver performance: Non-dimmable/dimmable
Dimmer: DALI/0~10v/Triac

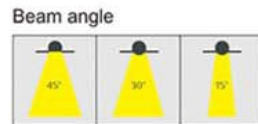

FS5049A-26
Max.26W

Operating Temp. : -30°C + 40°C
23W COB chip (DC700mA)
 ■ 2700K/1825lm Ra90
 ■ 3000K/2028lm Ra90
 ■ 4000K/2288lm Ra80
 ■ 5000K/2548lm Ra70

Remote Driver: AC100-240V 50/60Hz
Driver performance: Non-dimmable/dimmable
Dimmer: DALI/0~10v/Triac

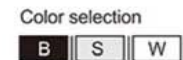
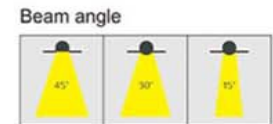

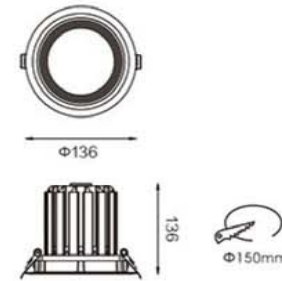

FS5077-42
Max.42W

- Operating Temp. : -30°C + 40°C
 38W COB chip (DC1000mA)
- 2700K/2958lm Ra90
 - 3000K/3360lm Ra90
 - 4000K/3696lm Ra80
 - 5000K/4116lm Ra70

Remote Driver: AC100-240V 50/60Hz
 Driver performance: Non-dimmable/dimmable
 Dimmer: DALI/0-10v/Triac



Frosted Glass



Clear Glass

Beam angle

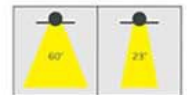

Color selection



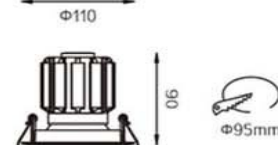
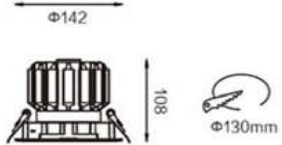

Frosted Glass



Clear Glass



Frosted Glass



Clear Glass

FS5052-20
Max. 18W

Operating Temp. : -30°C + 40°C

17.5W COB chip (DC500mA)

- 2700K 1418lm Ra90
- 3000K 1560lm Ra90
- 4000K 1760lm Ra80
- 5000K 1960lm Ra70

Remote Driver: AC100-240V 50/60Hz
Driver performance: Non-dimmable/dimmable
Dimmer: DALI/0~10v/Triac

Beam angle

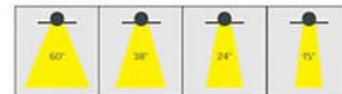

Color selection



FS5051-12
Max. 12W

Operating Temp. : -30°C + 40°C

11W COB chip (DC300mA)

- 2700K/840lm Ra90
- 3000K/936lm Ra90
- 4000K/1056lm Ra80
- 5000K/1176lm Ra70

Remote Driver: AC100-240V 50/60Hz
Driver performance: Non-dimmable/dimmable
Dimmer: DALI/0~10v/Triac

Beam angle

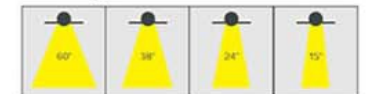

Color selection

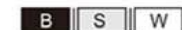



Soft and uniform light spot, no stray light.

光斑柔合、均匀、无杂光。



Perfect light shape, makes a comfortable, luxurious visual effect, The Lighting Designers' first option.



Ultra-narrow width design, make your decoration effect more artistic and modern

Simple, elegant, unique design, easy to disassemble
Perfect light shape, lighting designers' first option
2 styles (adjustable/non-adjustable) for selection

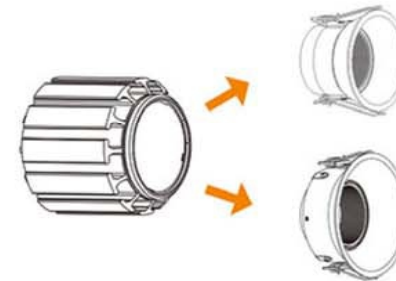

Simple, elegant, unique design, easy to disassemble

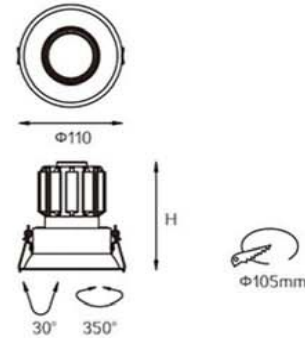
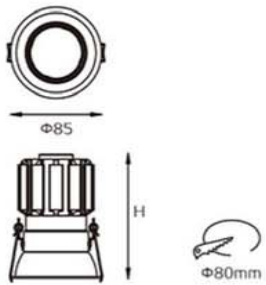

| Model | P | H |
|-----------|---------|-----|
| FS5071-14 | Max.14W | 118 |
| FS5071-18 | Max.18W | 128 |

| Model | P | H |
|-----------|---------|-----|
| FS5073-14 | Max.14W | 115 |
| FS5073-18 | Max.18W | 125 |

- Operating Temp. : -30°C + 40°C
 12W / 16W COB chip (DC300mA / DC500mA)
- 2700K/851lm 1260lm Ra90
 - 3000K/936lm 1368lm Ra90
 - 4000K/1056lm 1584lm Ra80
 - 5000K/1176lm 1728lm Ra70

Remote Driver: AC100-240V 50/60Hz
 Driver performance: Non-dimmable/dimmable
 Dimmer: DALI/0~10v/Triac

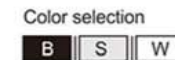
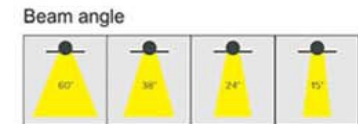
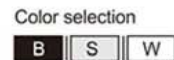
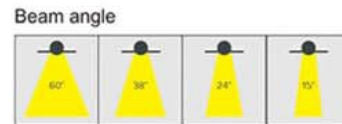

- Operating Temp. : -30°C + 40°C
 12W / 16W COB chip (DC300mA / DC500mA)
- 2700K/851lm 1260lm Ra90
 - 3000K/936lm 1368lm Ra90
 - 4000K/1056lm 1584lm Ra80
 - 5000K/1176lm 1728lm Ra70

Remote Driver: AC100-240V 50/60Hz
 Driver performance: Non-dimmable/dimmable
 Dimmer: DALI/0~10v/Triac

SPOT LIGHT

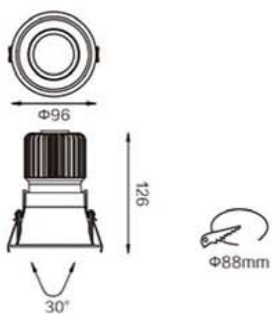

FS1055-16 Max. 16W

Operating Temp. : -30°C + 40°C

14W COB chip (DC350mA)

- 2700K/1120lm Ra90
- 3000K/1286lm Ra90
- 4000K/1440lm Ra80
- 5000K/1568lm Ra70

Remote Driver: AC100-240V 50/60Hz

Driver performance: Non-dimmable/dimmable

Dimmer: DALI/0~10v/Triac



Frosted Glass



Clear Glass

Beam angle



Color selection

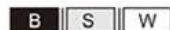

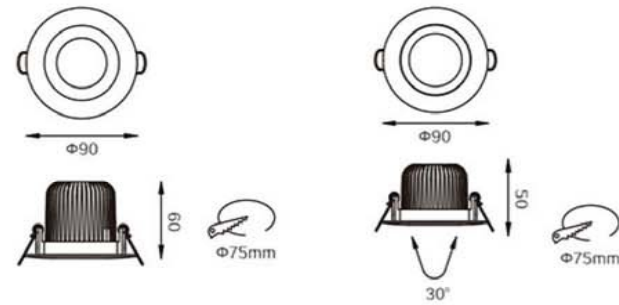
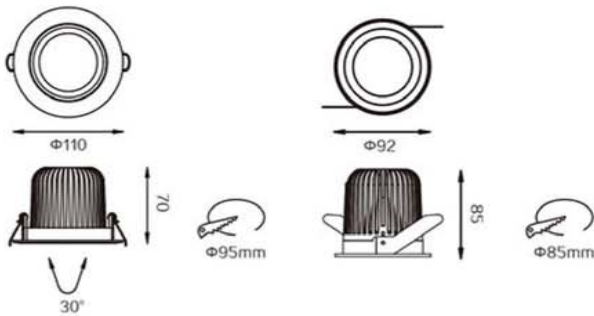

FS1022-16 / FS5076-14
Max.16W

Operating Temp. : -30°C + 40°C
14W COB chip (DC600mA)

- 2700K/1120lm Ra90
- 3000K/1248lm Ra90
- 4000K/1408lm Ra80
- 5000K/1568lm Ra70

Remote Driver: AC100-240V 50/60Hz
Driver performance: Non-dimmable/dimmable
Dimmer: DALI/0~10v/Triac

Beam angle



Color selection



FS1008-09 / FS1007-09
Max.9W

Operating Temp. : -30°C + 40°C
7.5W COB chip (DC350mA)

- 2700K/635lm Ra90
- 3000K/712lm Ra90
- 4000K/792lm Ra80
- 5000K/886lm Ra70

Remote Driver: AC100-240V 50/60Hz
Driver performance: Non-dimmable/dimmable
Dimmer: DALI/0~10v/Triac

Beam angle

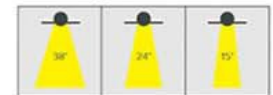

Color selection



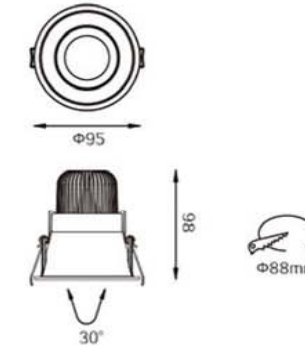
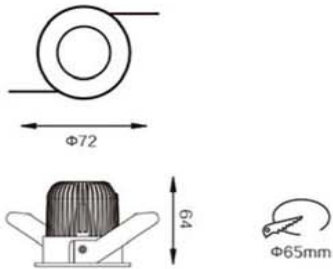

FS5075-09
Max.9W

Operating Temp. : -30°C + 40°C
7.5W COB chip (DC350mA)
 ■ 2700K/635lm Ra90
 ■ 3000K/712lm Ra90
 ■ 4000K/792lm Ra80
 ■ 5000K/886lm Ra70

Remote Driver: AC100-240V 50/60Hz
Driver performance: Non-dimmable/dimmable
Dimmer: DALI/0~10v/Triac

Beam angle

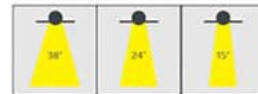

Color selection

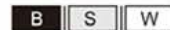

FS1061-09
Max.9W

Operating Temp. : -30°C + 40°C
7.5W COB chip (DC350mA)
 ■ 2700K/635lm Ra90
 ■ 3000K/712lm Ra90
 ■ 4000K/792lm Ra80
 ■ 5000K/886lm Ra70

Remote Driver: AC100-240V 50/60Hz
Driver performance: Non-dimmable/dimmable
Dimmer: DALI/0~10v/Triac

Beam angle

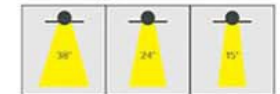

Color selection



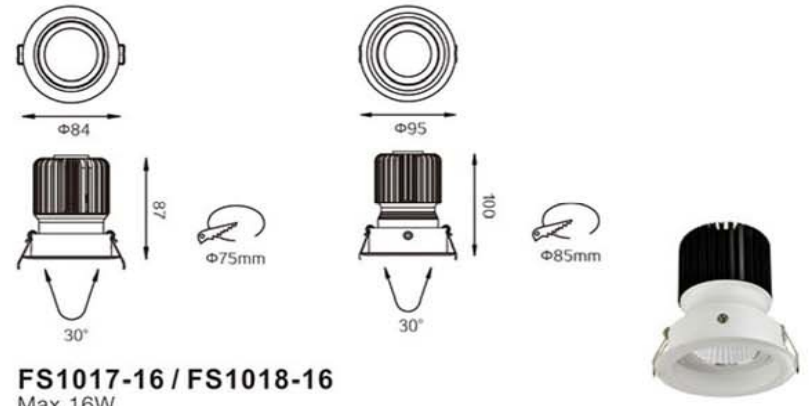
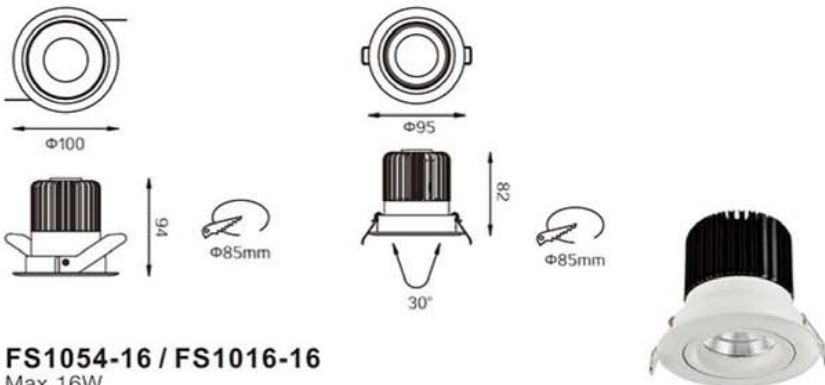

Operating Temp. : -30°C + 40°C
14W COB chip (DC350mA)

- 2700K/1120lm Ra90
- 3000K/1256lm Ra90
- 4000K/1408lm Ra80
- 5000K/1568lm Ra70

Remote Driver: AC100-240V 50/60Hz
Driver performance: Non-dimmable/dimmable
Dimmer: DALI/0~10v/Triac

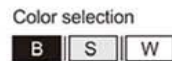
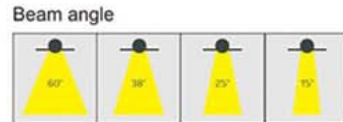

Operating Temp. : -30°C + 40°C
14W COB chip (DC600mA)

- 2700K/1120lm Ra90
- 3000K/1248lm Ra90
- 4000K/1408lm Ra80
- 5000K/1568lm Ra70

Remote Driver: AC100-240V 50/60Hz
Driver performance: Non-dimmable/dimmable
Dimmer: DALI/0~10v/Triac

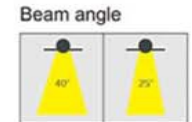



Recessed LED wall washer with white powder coated anti-glare die-cast housing, high thermal conductive heat sink and energy efficient electronic driver, Different shape of housing can be chosen in different application .

Application:living rooms, corridors, shops, shopping mall, hotel, restaurants.

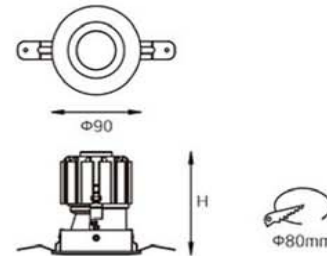

Frosted Glass



Clear Glass



| Model | P | H |
|-----------|---------|-----|
| FS6001-09 | Max.9W | 104 |
| FS6001-15 | Max.15W | 116 |

Operating Temp. : -30°C + 40°C
7.5W / 13.5W COB chip (DC200mA / DC350mA)

- 2700K/639lm 1065lm Ra90
- 3000K/702lm 1170lm Ra90
- 4000K/792lm 1320lm Ra80
- 5000K/882lm 1425lm Ra70

Beam angle



Color selection



Remote Driver: AC100-240V 50/60Hz
Driver performance: Non-dimmable/dimmable
Dimmer: DALI/0-10v/Triac



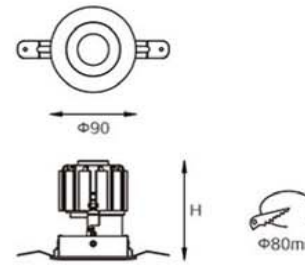
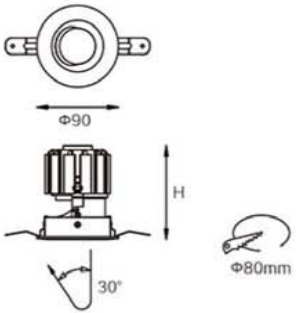

| Model | P | H |
|-----------|---------|-----|
| FS6002-09 | Max.9W | 104 |
| FS6002-15 | Max.15W | 116 |

| Model | P | H |
|-----------|---------|-----|
| FS6003-09 | Max.9W | 104 |
| FS6003-15 | Max.15W | 116 |



- Operating Temp. : -30°C + 40°C
 7.5W / 13.5W COB chip (DC200mA / DC350mA)
- 2700K/639lm 1065lm Ra90
 - 3000K/702lm 1170lm Ra90
 - 4000K/792lm 1320lm Ra80
 - 5000K/882lm 1425lm Ra70

Remote Driver: AC100-240V 50/60Hz
 Driver performance: Non-dimmable/dimmable
 Dimmer: DALI/0~10v/Triac

Beam angle: 15° / 25° / 38°



Color selection

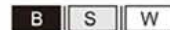

- Operating Temp. : -30°C + 40°C
 7.5W / 13.5W COB chip (DC200mA / DC350mA)
- 2700K/639lm 1065lm Ra90
 - 3000K/702lm 1170lm Ra90
 - 4000K/792lm 1320lm Ra80
 - 5000K/882lm 1425lm Ra70

Remote Driver: AC100-240V 50/60Hz
 Driver performance: Non-dimmable/dimmable
 Dimmer: DALI/0~10v/Triac

Beam angle

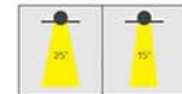

Color selection

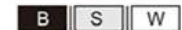

HOTEL DOWNLIGHT

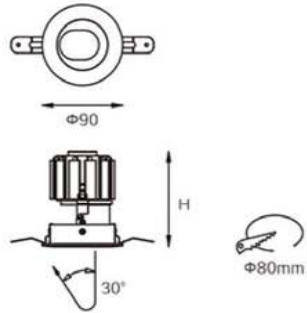

| Model | P | H |
|-----------|---------|-----|
| FS6004-09 | Max.9W | 104 |
| FS6004-15 | Max.15W | 116 |

- Operating Temp. : -30°C + 40°C
 7.5W / 13.5W COB chip (DC200mA / DC350mA)
- 2700K/639lm 1065lm Ra90
 - 3000K/702lm 1170lm Ra90
 - 4000K/792lm 1320lm Ra80
 - 5000K/882lm 1425lm Ra70

Remote Driver: AC100-240V 50/60Hz
 Driver performance: Non-dimmable/dimmable
 Dimmer: DALI/0~10v/Triac

Beam angle: 15° / 25° / 38°



Color selection

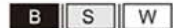

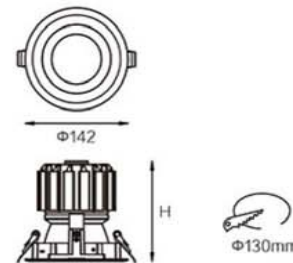

| Model | P | H |
|-----------|---------|-----|
| FS6006-20 | Max.20W | 139 |
| FS6006-30 | Max.30W | 154 |
| FS6006-42 | Max.42W | 179 |

- Operating Temp. : -30°C + 40°C
 18W COB chip (DC500mA)
- 2700K/1260lm Ra90
 - 3000K/1418lm Ra90
 - 4000K/1585lm Ra80
 - 5000K/1764lm Ra70

Beam angle



Color selection



Remote Driver: AC100-240V 50/60Hz
 Driver performance: Non-dimmable/dimmable
 Dimmer: DALI/0~10v/Triac





Φ142

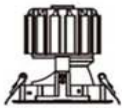

30°



Φ130mm



Frosted Glass



Clear Glass

| Model | P | H |
|-----------|---------|-----|
| FS6007-20 | Max.20W | 139 |
| FS6007-30 | Max.30W | 154 |
| FS6007-42 | Max.42W | 179 |

Operating Temp. : -30°C + 40°C

18W COB chip (DC500mA)

■ 2700K/1260lm Ra90

■ 3000K/1418lm Ra90

■ 4000K/1585lm Ra80

■ 5000K/1764lm Ra70

Remote Driver: AC100-240V 50/60Hz

Driver performance: Non-dimmable/dimmable

Dimmer: DALI/0~10v/Triac

Beam angle:15° /24° /38°



Color selection

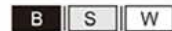

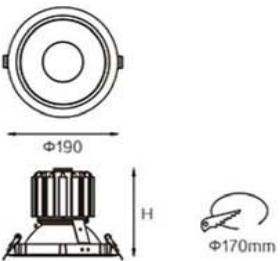

| Model | P | H |
|-----------|---------|-----|
| FS6010-30 | Max.30W | 151 |
| FS6010-42 | Max.42W | 176 |

Operating Temp. : -30°C + 40°C

27W COB chip (DC700mA)

- 2700K/2106lm Ra90
- 3000K/2280lm Ra90
- 4000K/2640lm Ra80
- 5000K/2880lm Ra70

Remote Driver: AC100-240V 50/60Hz
 Driver performance: Non-dimmable/dimmable
 Dimmer: DALI/0~10v/Triac



Frosted Glass



Clear Glass

Beam angle

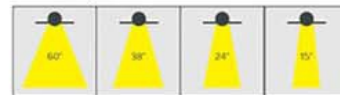

Color selection

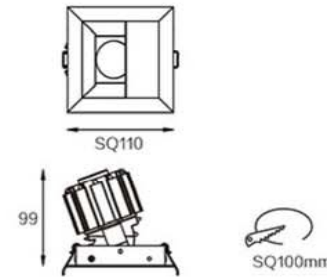
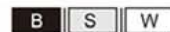

FS5039-12
 Max.12W

Operating Temp. : -30°C + 40°C

10W COB chip (DC250mA)

- 2700K/845lm Ra90
- 3000K/936lm Ra90
- 4000K/1068lm Ra80
- 5000K/1165lm Ra70

Remote Driver: AC100-240V 50/60Hz
 Driver performance: Non-dimmable/dimmable
 Dimmer: 0~10v/Triac

Beam angle



Color selection

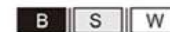

RECESSED DOWNLIGHT

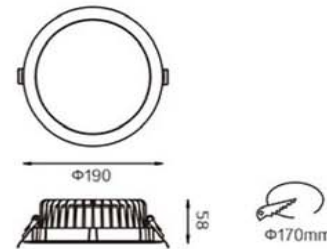
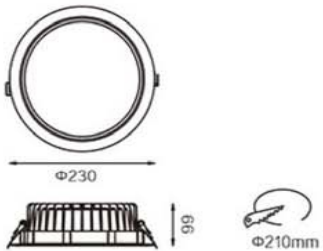

FS3002-24 Max.24W

Operating Temp. : -30°C + 40°C
SMD2835*90PCS (DC700mA)

- 2700K/1680lm Ra90
- 3000K/1872lm Ra90
- 4000K/2112lm Ra80
- 5000K/2352lm Ra70

Remote Driver: AC100-240V 50/60Hz
Driver performance: Non-dimmable/dimmable
Dimmer: DALI/0~10v/Triac



Color selection

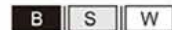

FS3001-19 Max.19W

Operating Temp. : -30°C + 40°C
SMD2835*80PCS (DC700mA)

- 2700K/1330lm Ra90
- 3000K/1482lm Ra90
- 4000K/1672lm Ra80
- 5000K/1862lm Ra70

Remote Driver: AC100-240V 50/60Hz
Driver performance: Non-dimmable/dimmable
Dimmer: DALI/0~10v/Triac



Color selection

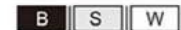

RECESSED DOWNLIGHT

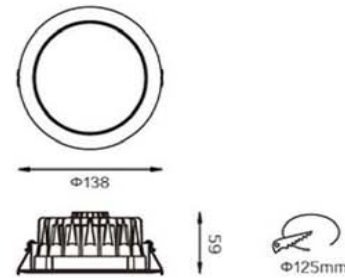
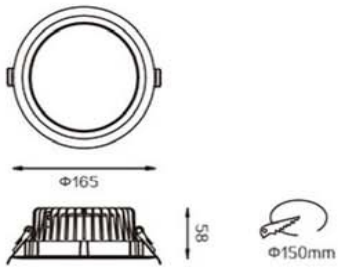

FS3022-15

Max. 15W

Operating Temp. : -30°C + 40°C

SMD2835*70PCS (DC300mA)

- 2700K/1050lm Ra90
- 3000K/1170lm Ra90
- 4000K/1320lm Ra80
- 5000K/1470lm Ra70

Remote Driver: AC100-240V 50/60Hz

Driver performance: Non-dimmable/dimmable

Dimmer: DALI/0~10v/Triac



Color selection

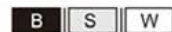

FS3021-13

Max. 13W

Operating Temp. : -30°C + 40°C

SMD2835*60PCS (DC300mA)

- 2700K/910lm Ra90
- 3000K/1014lm Ra90
- 4000K/1148lm Ra80
- 5000K/1274lm Ra70

Remote Driver: AC100-240V 50/60Hz

Driver performance: Non-dimmable/dimmable

Dimmer: DALI/0~10v/Triac



Color selection

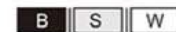

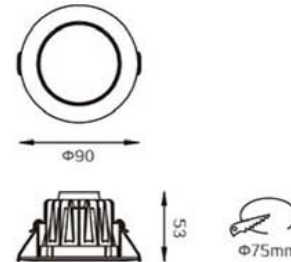
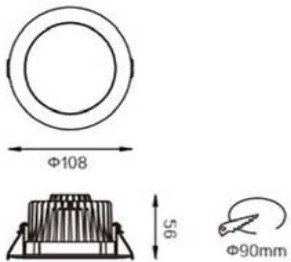

FS3020-10

Max.10W

Operating Temp. : -30°C + 40°C

SMD2835*45PCS (DC300mA)

- 2700K/716lm Ra90
- 3000K/786lm Ra90
- 4000K/880lm Ra80
- 5000K/980lm Ra70

Remote Driver: AC100-240V 50/60Hz

Driver performance: Non-dimmable/dimmable

Dimmer: DALI/0~10v/Triac



Color selection

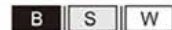

FS3023-07

Max.7W

Operating Temp. : -30°C + 40°C

SMD2835*30PCS (DC300mA)

- 2700K/490lm Ra90
- 3000K/546lm Ra90
- 4000K/616lm Ra80
- 5000K/686lm Ra70

Remote Driver: AC100-240V 50/60Hz

Driver performance: Non-dimmable/dimmable

Dimmer: 0~10v/Triac



Color selection



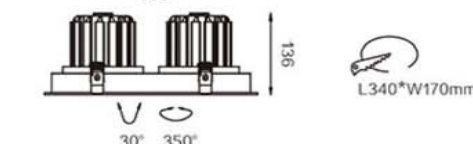
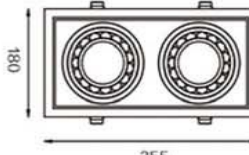
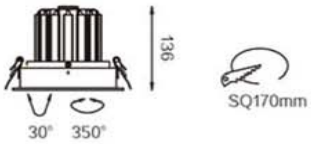
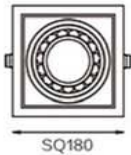

FS2019-35
Max.35W

- Operating Temp. : -30°C + 40°C
32W COB chip (DC800mA)
- 2700K/2450lm Ra90
 - 3000K/2730lm Ra90
 - 4000K/3080lm Ra80
 - 5000K/3360lm Ra70

Remote Driver: AC100-240V 50/60Hz
Driver performance: Non-dimmable/dimmable
Dimmer: DALI/0~10v/Triac

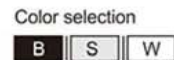
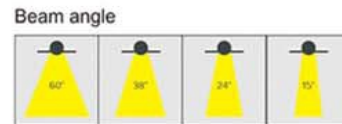

FS2018-35
Max.2*35W

- Operating Temp. : -30°C + 40°C
2*32W COB chip (DC800mA)
- 2700K/4915lm Ra90
 - 3000K/5390lm Ra90
 - 4000K/5950lm Ra80
 - 5000K/6720lm Ra70

Remote Driver: AC100-240V 50/60Hz
Driver performance: Non-dimmable/dimmable
Dimmer: DALI/0~10v/Triac

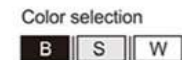
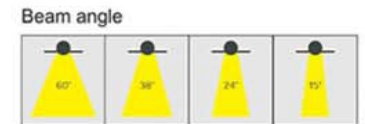

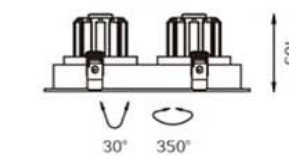
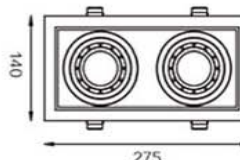
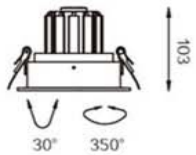
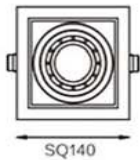

FS2023-15
Max. 15W

- Operating Temp. : -30°C + 40°C
13.5W COB chip (DC350mA)
- 2700K/1053lm Ra90
 - 3000K/1145lm Ra90
 - 4000K/1335lm Ra80
 - 5000K/1425lm Ra70

Remote Driver: AC100-240V 50/60Hz
Driver performance: Non-dimmable/dimmable
Dimmer: DALI/0~10v/Triac

Beam angle

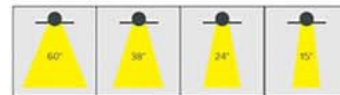

Color selection

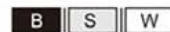

FS2022-15
Max. 2*15W

- Operating Temp. : -30°C + 40°C
2*13.5W COB chip (DC350mA)
- 2700K/2130lm Ra90
 - 3000K/2340lm Ra90
 - 4000K/2610lm Ra80
 - 5000K/2850lm Ra70

Remote Driver: AC100-240V 50/60Hz
Driver performance: Non-dimmable/dimmable
Dimmer: DALI/0~10v/Triac

Beam angle

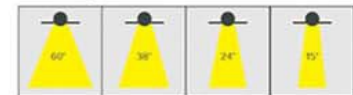

Color selection

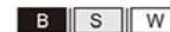

RECESSED GRILLE LIGHT

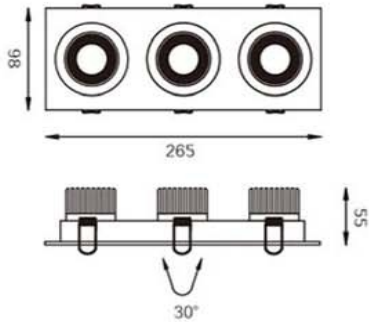

FS2026-3 Max.3*5W

Operating Temp. : -30°C + 40°C
3*4.5W COB chip (DC450mA)

- 2700K/1050lm Ra90
- 3000K/1170lm Ra90
- 4000K/1320lm Ra80
- 5000K/1425lm Ra70

Remote Driver: AC100-240V 50/60Hz
Driver performance: Non-dimmable/dimmable
Dimmer: DALI/0~10v/Triac

Beam angle

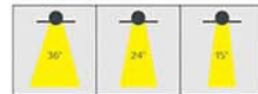

Color selection

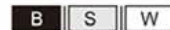

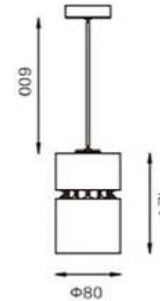
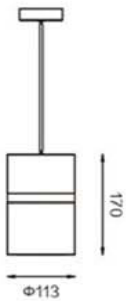

FS3020-40

Max.40W

Operating Temp. : -30°C + 40°C

35W COB chip (DC900mA)

- 2700K/2815lm Ra90
- 3000K/3120lm Ra90
- 4000K/3520lm Ra80
- 5000K/3925lm Ra70

Remote Driver: AC100-240V 50/60Hz

Driver performance: Non-dimmable/dimmable

Dimmer: 0~10v/Triac

Beam angle



Color selection

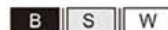

FS4010B-18

Max.18W

Operating Temp. : -30°C + 40°C

16W COB chip (DC450mA)

- 2700K/1260lm Ra90
- 3000K/1405lm Ra90
- 4000K/1584lm Ra80
- 5000K/1766lm Ra70

Remote Driver: AC100-240V 50/60Hz

Driver performance: Non-dimmable/dimmable

Dimmer: 0~10v/Triac

Beam angle



Color selection



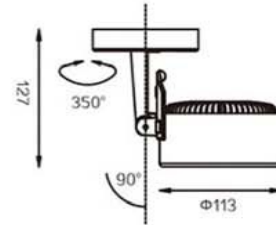
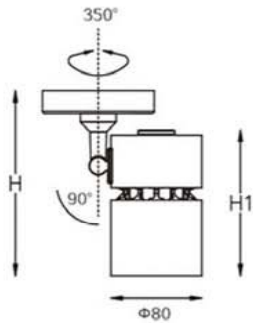

| Model | P | H | H1 |
|------------|---------|-----|-----|
| FS4010D-12 | Max.12W | 143 | 108 |
| FS4010D-18 | Max.18W | 163 | 128 |
| FS4010D-22 | Max.22W | 173 | 138 |

Operating Temp. : -30°C + 40°C
 16W COB chip (DC450mA) / FS4010D-18
 ■ 2700K/1260lm Ra90
 ■ 3000K/1405lm Ra90
 ■ 4000K/1584lm Ra80
 ■ 5000K/1766lm Ra70

Remote Driver: AC100-240V 50/60Hz
 Driver performance: Non-dimmable/dimmable
 Dimmer: 0~10v/Triac

Beam angle



Color selection

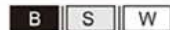

FS4001B-26
Max.26W

Operating Temp. : -30°C + 40°C
 23W COB chip (DC600mA)
 ■ 2700K/1820lm Ra90
 ■ 3000K/2028lm Ra90
 ■ 4000K/2288lm Ra80
 ■ 5000K/2550lm Ra70

Remote Driver: AC100-240V 50/60Hz
 Driver performance: Non-dimmable/dimmable
 Dimmer: DALI/0~10v/Triac



Beam angle



Color selection

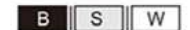

PENDENT LIGHT

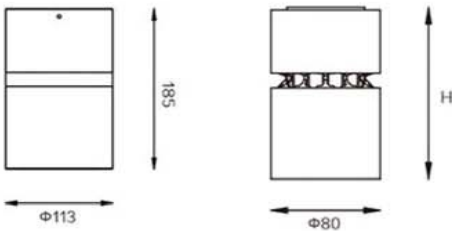

| Model | P | H |
|------------|---------|-----|
| FS3019-40 | Max.40W | 185 |
| FS4010C-12 | Max.12W | 108 |
| FS4010C-18 | Max.18W | 128 |
| FS4010C-22 | Max.22W | 138 |

Operating Temp. : -30°C + 40°C
 37W COB chip (DC1000mA) / FS3019-40

- 2700K/2815lm Ra90
- 3000K/3120lm Ra90
- 4000K/3520lm Ra80
- 5000K/3925lm Ra70

Remote Driver: AC100-240V 50/60Hz
 Driver performance: Non-dimmable/dimmable
 Dimmer: 0~10v/Triac



Beam angle



Color selection

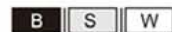



No Trace Of Light

The space was lighting without seeing any lighting trace A special design micro reflector, makes you a comfortable space intensive design lens, combine high precision micro reflector and anti glare metal balck grating body, makes UGR < 19

LINEAR LIGHT



FS8005-11 / 6*1.6W LED / 750lm / 2700K / Ra90



FS8006-22 / 12*1.6W LED / 1500lm / 2700K / Ra90



FS8007-33 / 18*1.6W LED / 2250lm / 2700K / Ra90

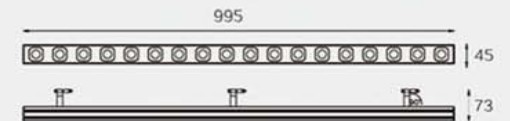
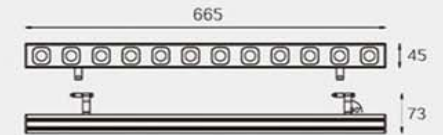
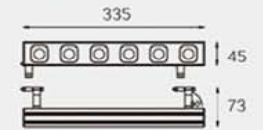



CORNER LIGHT

Recessed LED Corner Light with high quality aluminum body in powder-coated, with multiple anti-glare reflecting angles, excellent heatsink capability to minimize degradation of the lumens, remote LED driver.

Application: hotel, museum, exhibition hall restaurant, coffee shop.

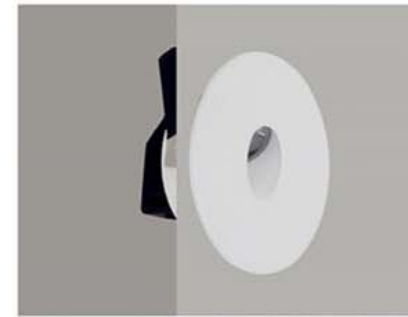

FS5026-02

Max.3W

Operating Temp. : -30°C + 40°C

2W COB chip (DC500mA)

■ 2700K/213lm Ra90

■ 3000K/234lm Ra90

■ 4000K/258lm Ra80

■ 5000K/291lm Ra70

Remote Driver: AC100-240V 50/60Hz

Driver performance: Non-dimmable/dimmable

Dimmer: 0~10v/Triac



Beam angle

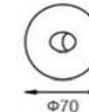
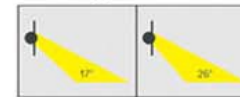

Color selection

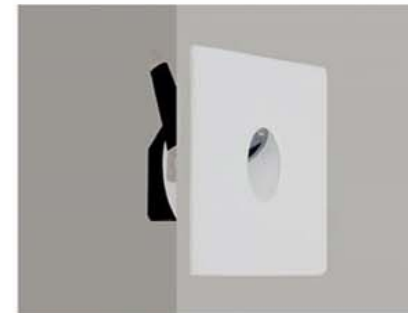

FS5027-02

Max.3W

Operating Temp. : -30°C + 40°C

2W COB chip (DC500mA)

■ 2700K/213lm Ra90

■ 3000K/234lm Ra90

■ 4000K/258lm Ra80

■ 5000K/291lm Ra70

Remote Driver: AC100-240V 50/60Hz

Driver performance: Non-dimmable/dimmable

Dimmer: 0~10v/Triac



Beam angle

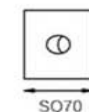
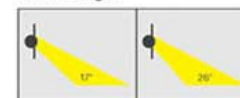

Color selection

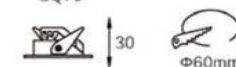

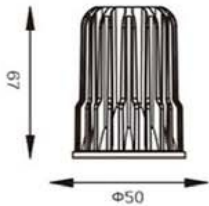

FS1059-09

Max.9W

Operating Temp. : -30°C + 40°C

7.5W COB chip (DC350mA)

- 2700K/630lm Ra90
- 3000K/702lm Ra90
- 4000K/783lm Ra80
- 5000K/864lm Ra70

Remote Driver: AC100-240V 50/60Hz

Driver performance: Non-dimmable/dimmable

Dimmer: 0~10v/Triac



Beam angle

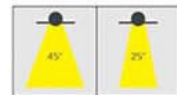

Color selection

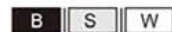

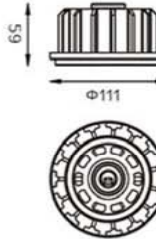
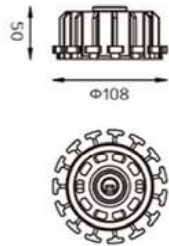

FS7001A-AR111

Max.14W

Operating Temp. : -30°C + 40°C

12W COB chip (DC300mA)

- 2700K/980lm Ra90
- 3000K/1092lm Ra90
- 4000K/1232lm Ra80
- 5000K/1372lm Ra70

Remote Driver: AC100-240V 50/60Hz

Driver performance: Non-dimmable/dimmable

Dimmer: 0~10v/Triac

Beam angle

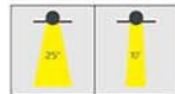

Color selection

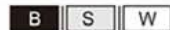

FS7001-AR111

Max.15W

Operating Temp. : -30°C + 40°C

13.5W COB chip (DC350mA)

- 2700K/1065lm Ra90
- 3000K/1155lm Ra90
- 4000K/1320lm Ra80
- 5000K/1440lm Ra70

Remote Driver: AC100-240V 50/60Hz

Driver performance: Non-dimmable/dimmable

Dimmer: 0~10v/Triac

Beam angle

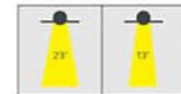

Color selection





LED TRACK LIGHT

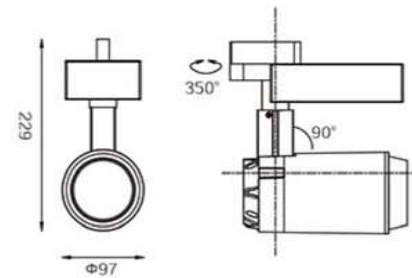

FS4013-42

Max.42W

Operating Temp. : -30°C + 40°C

38W COB chip (DC1000mA)

- 2700K/2958lm Ra90
- 3000K/3360lm Ra90
- 4000K/3696lm Ra80
- 5000K/4116lm Ra70

Remote Driver: AC100-240V 50/60Hz

Driver performance: Non-dimmable/dimmable

Dimmer: DALI/0~10v/Triac

Beam angle



Color selection

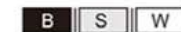

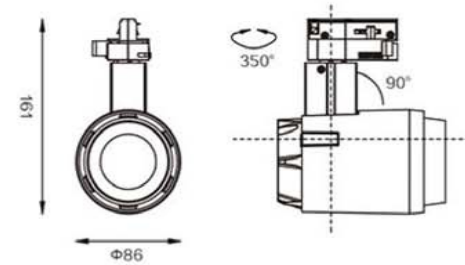
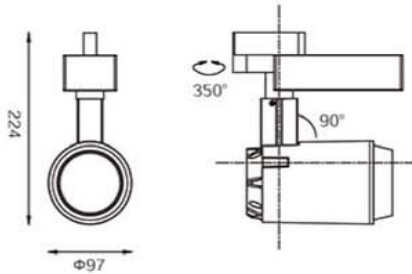

FS4012-30

Max.30W

Operating Temp. : -30°C + 40°C
26W COB chip (DC700mA) / FS1060-30

- 2700K/2107lm Ra90
- 3000K/2340lm Ra90
- 4000K/2645lm Ra80
- 5000K/2943lm Ra70

Remote Driver: AC100-240V 50/60Hz
Driver performance: Non-dimmable/dimmable
Dimmer: DALI/0~10v/Triac

Beam angle



Color selection

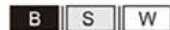

FS4011-15

Max.15W

Operating Temp. : -30°C + 40°C
13W COB chip (DC350mA)

- 2700K/1050lm Ra90
- 3000K/1170lm Ra90
- 4000K/1320lm Ra80
- 5000K/1470lm Ra70

Remote Driver: AC100-240V 50/60Hz
Driver performance: Non-dimmable/dimmable
Dimmer: 0~10v/Triac

Beam angle



Color selection

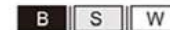

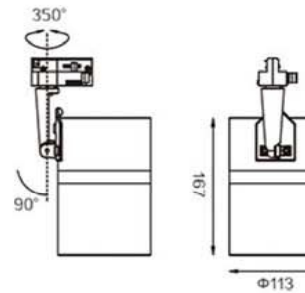
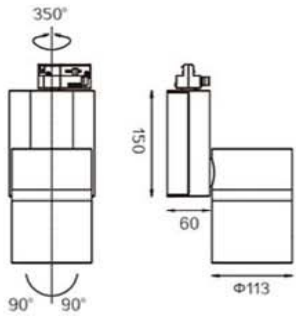

FS4005-42

Max.42W

Operating Temp. : -30°C + 40°C

38W COB chip (DC1000mA)

- 2700K/2958lm Ra90
- 3000K/3360lm Ra90
- 4000K/3696lm Ra80
- 5000K/4116lm Ra70

Remote Driver: AC100-240V 50/60Hz

Driver performance: Non-dimmable/dimmable

Dimmer: DALI/0~10v/Triac

Beam angle



Color selection

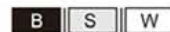

FS4006-42

Max.42W

Operating Temp. : -30°C + 40°C

38W COB chip (DC1000mA)

- 2700K/2958lm Ra90
- 3000K/3360lm Ra90
- 4000K/3696lm Ra80
- 5000K/4116lm Ra70

Remote Driver: AC100-240V 50/60Hz

Driver performance: Non-dimmable/dimmable

Dimmer: 0~10v/Triac

Beam angle



Color selection



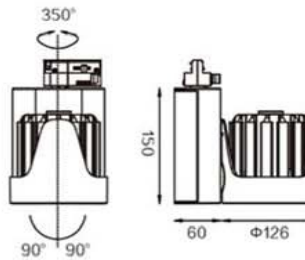
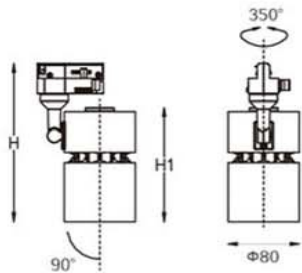

| Model | P | H | H1 |
|-----------|---------|-----|-----|
| FS4010-12 | Max.12W | 178 | 108 |
| FS4010-18 | Max.18W | 205 | 128 |
| FS4010-22 | Max.22W | 213 | 138 |

FS4007-42
Max.42W

Operating Temp. : -30°C + 40°C
 16W COB chip (DC450mA) / FS4010-18
 ■ 2700K/1260lm Ra90
 ■ 3000K/1418lm Ra90
 ■ 4000K/1585lm Ra80
 ■ 5000K/1764lm Ra70

Remote Driver: AC100-240V 50/60Hz
 Driver performance: Non-dimmable/dimmable
 Dimmer: 0~10v/Triac

Beam angle



Color selection

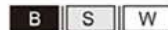

Operating Temp. : -30°C + 40°C
 38W COB chip (DC1000mA)
 ■ 2700K/2958lm Ra90
 ■ 3000K/3360lm Ra90
 ■ 4000K/3696lm Ra80
 ■ 5000K/4116lm Ra70

Remote Driver: AC100-240V 50/60Hz
 Driver performance: Non-dimmable/dimmable
 Dimmer: DALI/0~10v/Triac

Beam angle



Color selection

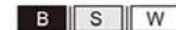

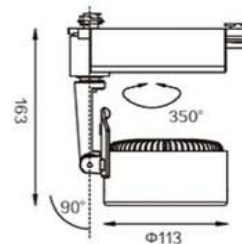
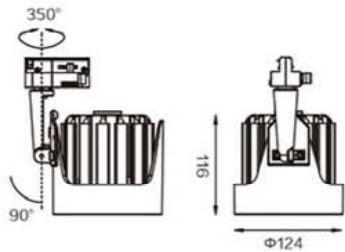

FS4008-42
Max.42W

Operating Temp. : -30°C + 40°C
38W COB chip (DC1000mA)

- 2700K/2958lm Ra90
- 3000K/3360lm Ra90
- 4000K/3696lm Ra80
- 5000K/4116lm Ra70

Remote Driver: AC100-240V 50/60Hz
Driver performance: Non-dimmable/dimmable
Dimmer: DALI/0~10v/Triac

Beam angle



Color selection

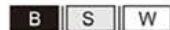

FS4001-26
Max.26W

Operating Temp. : -30°C + 40°C
23W COB chip (DC600mA)

- 2700K/1820lm Ra90
- 3000K/2028lm Ra90
- 4000K/2288lm Ra80
- 5000K/2550lm Ra70

Remote Driver: AC100-240V 50/60Hz
Driver performance: Non-dimmable/dimmable
Dimmer: DALI/0~10v/Triac

Beam angle



Color selection

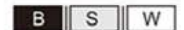

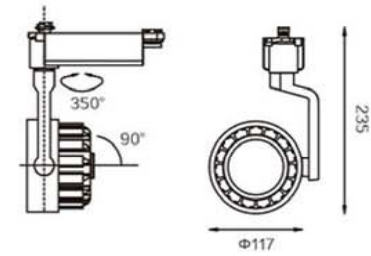
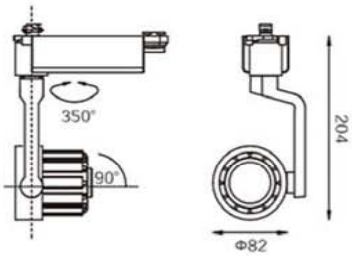

FS4009-15
Max.15W

- Operating Temp. : -30°C + 40°C
13W COB chip (DC 350 mA)
- 2700K/1050lm Ra90
 - 3000K/1170lm Ra90
 - 4000K/1328lm Ra80
 - 5000K/1476lm Ra70

Remote Driver: AC100-240V 50/60Hz
Driver performance: Non-dimmable/dimmable
Dimmer: DALI/0~10v/Triac

Beam angle



Color selection

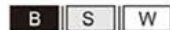

FS4009-25
Max.25W

- Operating Temp. : -30°C + 40°C
23W COB chip (DC600mA)
- 2700K/1750lm Ra90
 - 3000K/1975lm Ra90
 - 4000K/2250lm Ra80
 - 5000K/2450lm Ra70

Remote Driver: AC100-240V 50/60Hz
Driver performance: Non-dimmable/dimmable
Dimmer: DALI/0~10v/Triac

Beam angle



Color selection

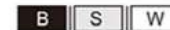

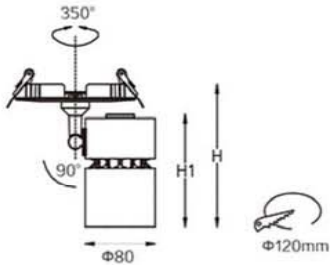

| Model | P | H | H1 |
|------------|---------|-----|-----|
| FS4010A-12 | Max.12W | 162 | 108 |
| FS4010A-18 | Max.18W | 180 | 128 |
| FS4010A-22 | Max.22W | 187 | 138 |

Operating Temp. : -30°C + 40°C
 16W COB chip (DC450mA) / FS4010A-18
 ■ 2700K/1260lm Ra90
 ■ 3000K/1418lm Ra90
 ■ 4000K/1585lm Ra80
 ■ 5000K/1764lm Ra70

Remote Driver: AC100-240V 50/60Hz
 Driver performance: Non-dimmable/dimmable
 Dimmer: 0~10v/Triac

Beam angle

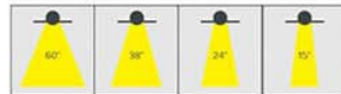

Color selection

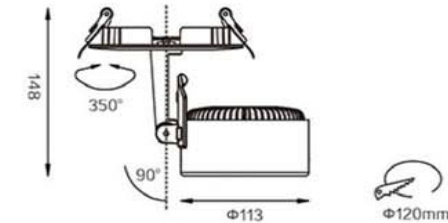

FS4001A-26
Max.26W

Operating Temp. : -30°C + 40°C
 23W COB chip (DC600mA)
 ■ 2700K/1820lm Ra90
 ■ 3000K/2028lm Ra90
 ■ 4000K/2288lm Ra80
 ■ 5000K/2548lm Ra70

Remote Driver: AC100-240V 50/60Hz
 Driver performance: Non-dimmable/dimmable
 Dimmer: DALI/0~10v/Triac



Beam angle

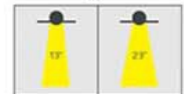

Color selection

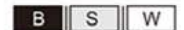



TRACK LIGHT

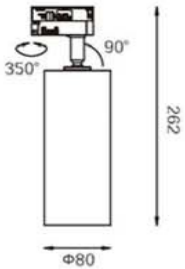

| Model | P | H |
|-----------|---------|-----|
| FS4014-18 | Max.18W | 262 |
| FS4014-25 | Max.25W | 262 |

Operating Temp. : -30°C + 40°C
16W COB chip (DC450mA) / FS4014-18

- 2700K/1260lm Ra90
- 3000K/1418lm Ra90
- 4000K/1585lm Ra80
- 5000K/1764lm Ra70

Remote Driver: AC100-240V 50/60Hz
Driver performance: Non-dimmable/dimmable
Dimmer: 0~10v/Triac

Beam angle



Color selection

